

## AL-512-01-921 white

**EnoDisc® / IP-ENOCEAN-BRIDGE PoE**  
**Bi-directional bridge between Ethernet-IP and EnOcean, Power Over Ethernet**  
**EnOcean 921.7 MHz / TAIWAN**

Version 1.14, valid since FW/HW 2.0 / 1.0

---

© 2023 DEUTA Controls GmbH

All rights reserved

This Manual, including all figures and illustrations, is copyright-protected. Any further use of this Manual by third parties that violate pertinent copyright provisions is prohibited. Reproduction, translation, electronic and phototechnical filing/archiving (e.g., photocopying) as well as any amendments require the written consent of DEUTA Controls GmbH, Bergisch Gladbach, Germany. Non-observance will involve the right to assert damage claims.

## DEUTA Controls GmbH

Paffrather Straße 140  
51465 Bergisch Gladbach  
Phone: +49 5734 51466 -15  
Fax: +49 5734 51466 -28  
E-Mail: [info@deuta-controls.de](mailto:info@deuta-controls.de)  
Web: [www.deuta-controls.net](http://www.deuta-controls.net)

Every conceivable measure has been taken to ensure the accuracy and completeness of this documentation. However, as errors can never be fully excluded, we always appreciate any information or suggestions for improving the documentation.

E-Mail: [info@deuta-controls.de](mailto:info@deuta-controls.de)

## Table of Contents

1	Validity of this documentation .....	5
2	Intended use .....	5
3	Disposal .....	5
4	Device description .....	5
4.1	Functionality .....	5
4.2	External product interface .....	6
4.3	Observe intended use .....	6
4.4	Observe statutory provisions for operating frequency range.....	6
4.5	Non-conduction mounting surface .....	6
5	Technical data .....	7
5.1	Communication / EnOcean wireless interface .....	7
5.2	Communication / Ethernet interface .....	7
5.3	User interfaces .....	7
5.4	Housing / connection technology.....	7
5.5	Power supply.....	8
5.6	Environmental conditions .....	8
5.7	Dimensions and weight .....	8
5.8	Approvals .....	8
5.9	Standards / approvals .....	8
6	Functional description in detail .....	9
6.1	Receiving and transmitting of EnOcean data, and transfer in ESP3 format .....	9
7	The AL-512-01-921 white / EnoDisc® webserver .....	10
7.1	“Home” / EnoDisc device info page .....	10
7.2	“EnOcean” / EnOcean data monitor .....	10
7.3	“Repeater” / EnOcean repeater configuration.....	11
7.3.1	Repeater / Mode .....	11
7.3.2	Repeater / Action .....	12
7.3.3	Repeater / Criterium .....	13
7.3.4	Repeater / Criterium value .....	13

---

7.3.5	Add or remove rules for the repeater .....	15
7.4	“Setup” / Ethernet and EnOcean interface properties .....	16
7.4.1	Password .....	16
7.4.2	Device properties .....	17
7.5	Supported EEP’s (EnOcean Equipment Profiles) .....	23
7.5.1	Transmit / TX and Receive / RX .....	23
8	Installation and maintenance / service .....	24
9	Device labels .....	26
10	NCC statement .....	26
11	Dimensions / drawings .....	27
12	RoHS Table .....	28
13	Ordering information .....	29
14	Revision history .....	30

## 1 Validity of this documentation

This documentation is only applicable to the product

### **AL-512-01-921 white (EnoDisc®)**

and is only applicable starting from products with FW/HW Version 2.0/1.0.

The device must only be installed and operated according to the instructions in this document.

## 2 Intended use

The **AL-512-01-921 white** must not be used in any relation with equipment that supports, directly or indirectly, human health or life or with applications that can result in danger for people, animals or real value.

## 3 Disposal



Electrical and electronic equipment may not be disposed of with household waste. This also applies to products without this symbol.

Electrical and electronic equipment contain materials and substances that can be harmful to the environment and health. Electrical and electronic equipment must be disposed of properly after use.

Note only for EU: WEEE 2012/19/EU applies throughout Europe. Directives and laws may vary nationally.

## 4 Device description

### 4.1 Functionality

The **AL-512-01-921 white** is used to interface sensors and actuators with EnOcean® wireless interface to an Ethernet based automation system.

The integrated radio interface (EnOcean) receives data like room temperature, humidity or presence detection from sensors and can send data to actuators.

At the same time, data is transferred to / from an automation system via the integrated Ethernet interface.

The standardized protocol used by the communication layer is the ESP3 format (EnOcean Serial Protocol Version 3). The **AL-512-01-921 white** does not interpret data.

The **AL-512-01-921 white** is supplied via PoE (Power Over Ethernet).

## 4.2 External product interface

The external product interface consists of the following items:

- RJ45 connector for Ethernet patch cable when opened
- Flat-ribbon connector to controller board
- Service-LED (green) when opened

Once the EnoDisc is mounted and the housing is closed, there is no visible or touchable user interface.

## 4.3 Observe intended use

The **AL-512-01-921 white** must not be used in any relation with equipment that supports, directly or indirectly, human health or life or with applications that can result in danger for people, animals or real value.

## 4.4 Observe statutory provisions for operating frequency range.

The **AL-512-01-921 white** must only be operated in compliance with the country-specific provisions regarding operation of radio equipment.

## 4.5 Non-conduction mounting surface

A non-conductive mounting surface is necessary.

Ensure the **AL-512-01-921 white** is mounted on a non-conductive surface. If it is not, performance may be adversely affected.

## 5 Technical data

### 5.1 Communication / EnOcean wireless interface

Type	EnOcean
Number	1
Operating frequency	921.7 MHz
Transmission power	0 dBm
Modulation type	FSK
Number of channels	Ch 24 (921,7 MHz)
Transfer / data rate	125 kbit/s

Table 1: Technical data / Wireless communication EnOcean

### 5.2 Communication / Ethernet interface

Type	Ethernet, 10/100 Mbit
Number	1
Galvanically isolation Ethernet / PoE	Ethernet: Yes / PoE: No

Table 2: Technical data / communication

### 5.3 User interfaces

Service button	-
Service LED	Green, inside the housing, to show link and activity status

Table 3: Technical data / user interfaces

### 5.4 Housing / connection technology

Connection technology	RJ45
Housing	Plastic, ABS, grey / white RAL 9002

Table 4: Technical data / housing

## 5.5 Power supply

Power supply voltage	PoE (nom. 48 V DC)
Power consumption	Typ. 0.7 W, max. 1.0 W

Table 5: Technical data / power supply

## 5.6 Environmental conditions

Operating temp.	0° .. +45 °C
Storage temp.	-20° ..+70 °C
Rel. humidity	10..95 % rel. humidity, non condensing
Protection class	IP20

Table 6: Technical data / environmental conditions

## 5.7 Dimensions and weight

Weight	95 g
Dimensions	Diameter: 110 mm, Height: 58 mm

Table 7: Technical data / dimensions and weight

## 5.8 Approvals

FCC Rule parts	15.249
----------------	--------

Table 8: Technical data / tests and approvals

## 5.9 Standards / approvals

NCC	 CCXXxxYYyyyZzW Will be updated finally
-----	---

Table 9: Technical data / Standards / approvals



## 6 Functional description in detail

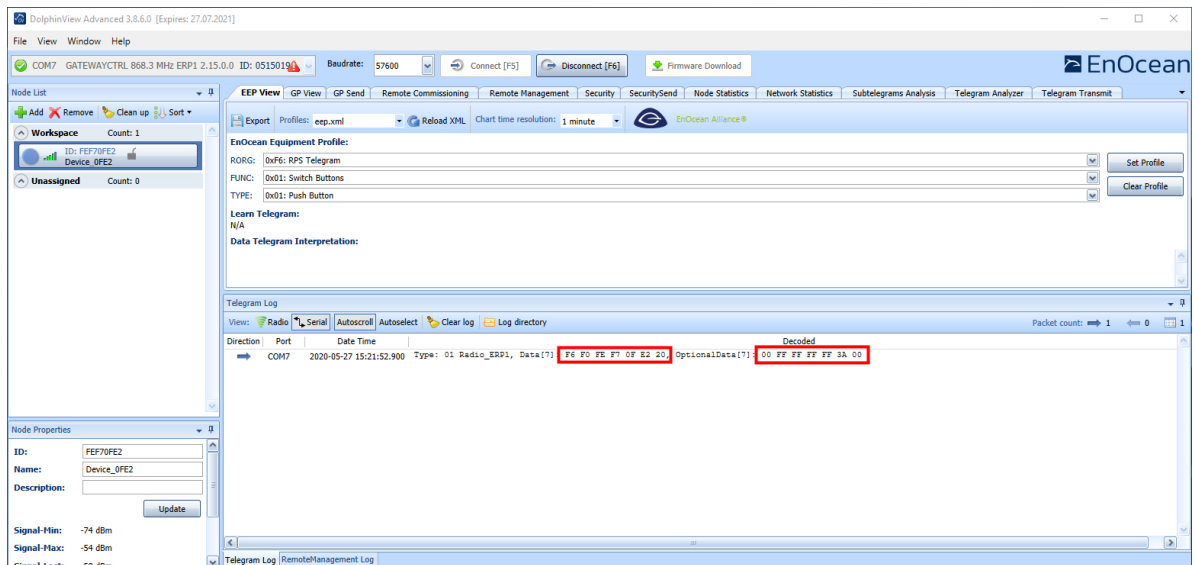
### 6.1 Receiving and transmitting of EnOcean data, and transfer in ESP3 format

EnOcean data will be received and transmitted by the EnOcean transceiver and an integrated PCB antenna. Once connected to the **AL-512-01-921 white** via Ethernet TCP on port 8424, data will be sent by / can be received by the EnoDisc®.

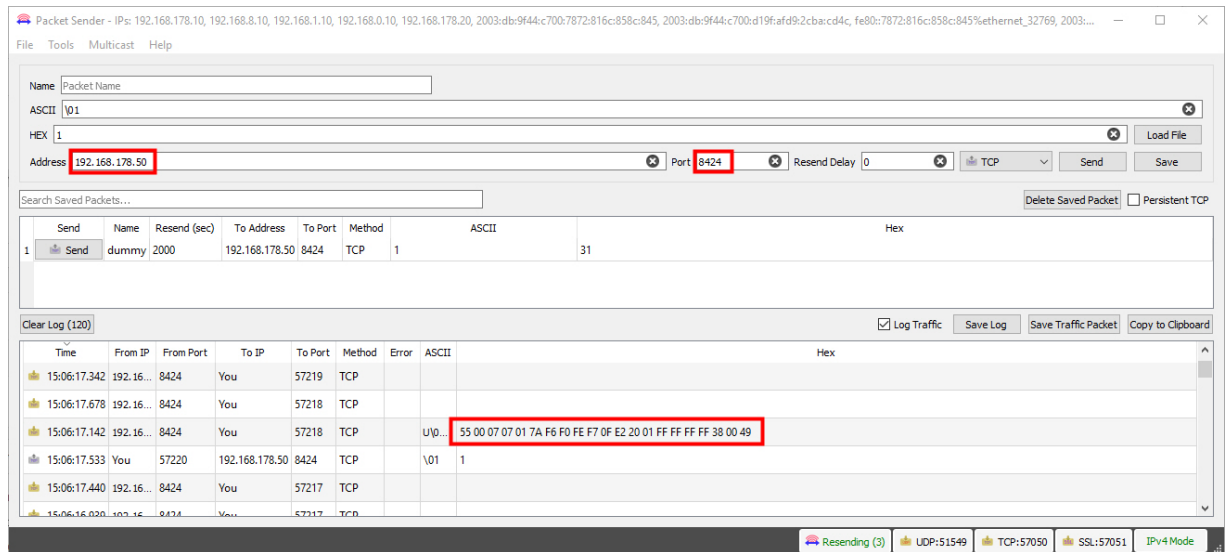
**Note:**

The Ethernet connection will be closed after 10 seconds without any data transfer.

As an example, the following picture shows data received via EnOcean, using the software tool Dolphin View.



Same data will be transferred by Ethernet.



## 7 The AL-512-01-921 white / EnoDisc® webserver

To support system installation and maintenance, the EnoDisc provides an integrated Webserver. The available functions are described below.

### 7.1 “Home” / EnoDisc device info page

On this page, the main properties of the EnoDisc are shown (Read only, can not be changed):

- Free text / device name
- Serial number / part nr.
- EURID
- BaseID
- Airtime
- HW- and SW-version
- IP address, subnet mask, gateway
- MAC
- Status DALI bus power supply voltage
- Runtime since last reset
- Sensitivity of the EnOcean receiver

### 7.2 “EnOcean” / EnOcean data monitor

EnOcean data received and send by the EnoDisc can be analyzed by the EnOcean monitor on this page. For each message, following data are recorded in a new line:

- Consecutive number of messages in the list
- Direction (receive / transmit)
- EnOcean-ID
- RORG
- Data
- Optional data
- Repeater level
- RSSI [dbm]
- Target address
- Time elapsed since last message
- Time stamp

### 7.3 “Repeater” / EnOcean repeater configuration

The EnoDisc allows to activate an EnOcean repeater (selective) if needed. By default, the repeater is disabled.

Using the drop-down list, the repeater function can be activated in different modes.

Available options are as follows:

#### 7.3.1 Repeater / Mode

<b>Level 1</b>	Any EnOcean telegram that has not been repeated before will be repeated / send again by the EnoDisc.
<b>Level 1 OR Filter</b>	This mode is a selective repeater mode which allows to define which kind of message should be repeated by the Level 1 repeater. More than one rule can be defined.
<b>Level 1 AND Filter</b>	This mode is a selective repeater mode which allows to define which kind of message should be repeated by the Level 1 repeater. More than one rule can be defined.
<b>Level 2</b>	Any EnOcean telegram that has not been already repeated by another level 2 repeater before will be send again by the EnoDisc.
<b>Level 2 OR Filter</b>	This mode is a selective repeater mode which allows to define which kind of message should be repeated. More than one rule can be defined.
<b>Level 2 AND Filter</b>	This mode is a selective repeater mode which allows to define which kind of message should be repeated. More than one rule can be defined.

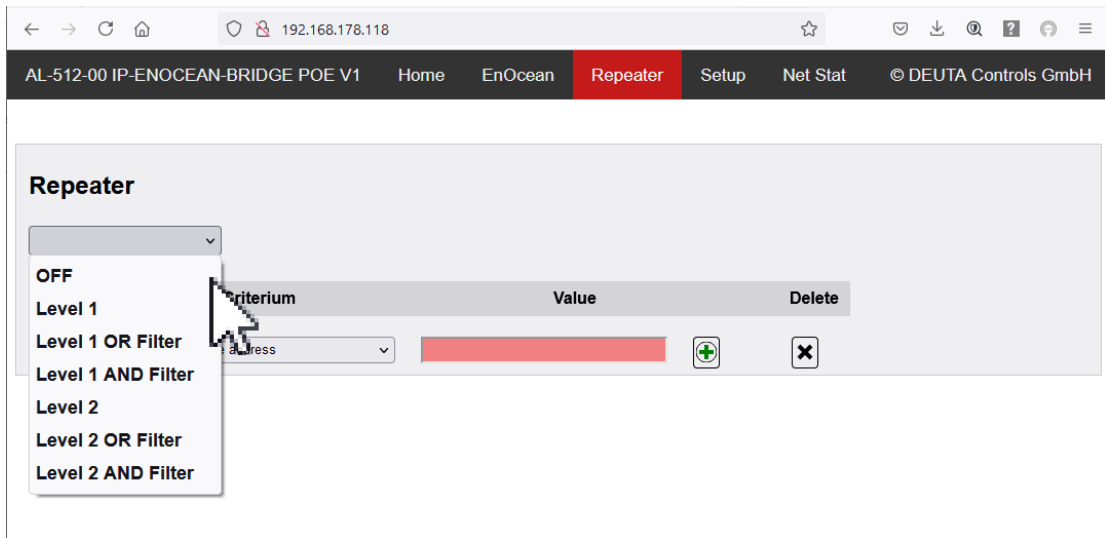


Figure 1: Repeater mode selection

### 7.3.2 Repeater / Action

If an “OR” or an “AND” filter mode is selected (Level 1 or Level 2), you can define if the rule will force (“Repeat”) or explicitly avoid (“Do not repeat”) to repeat the selected telegram type.

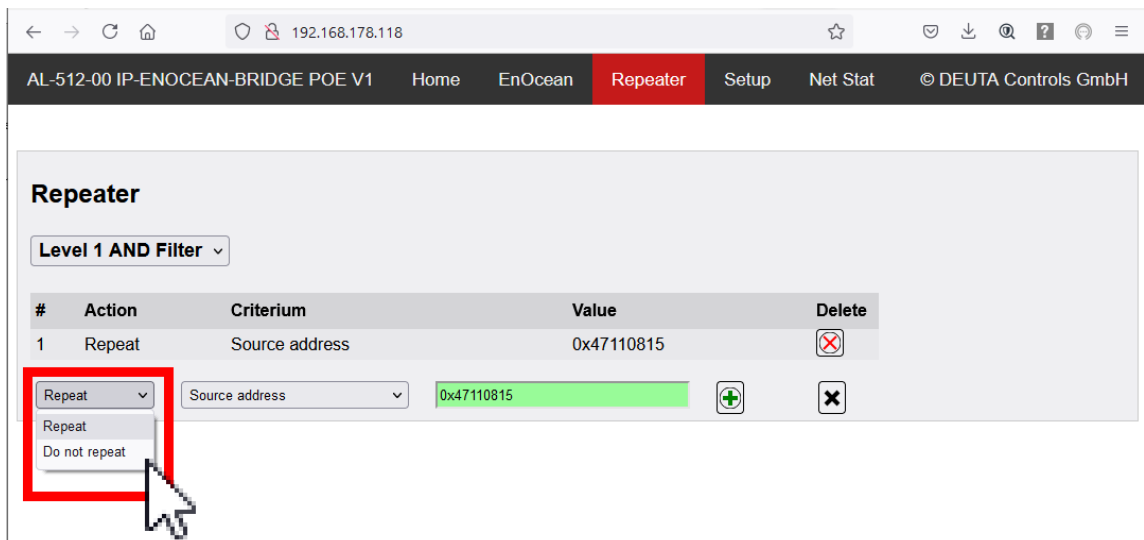


Figure 2: Repeater mode selection / Action force or block

### 7.3.3 Repeater / Criterium

Any repeater rule can be defined based on the properties of a received EnOcean message. The possible options are as follows:

- Source address** Only messages from this source address (EURID) will be repeated.
- Telegram type** Only messages of the selected message type will be repeated.
- Minimum signal strength (dBm)** Messages must have at least the selected signal strength to be repeated.
- Destination address** Only messages with this target address (EURID) will be repeated.

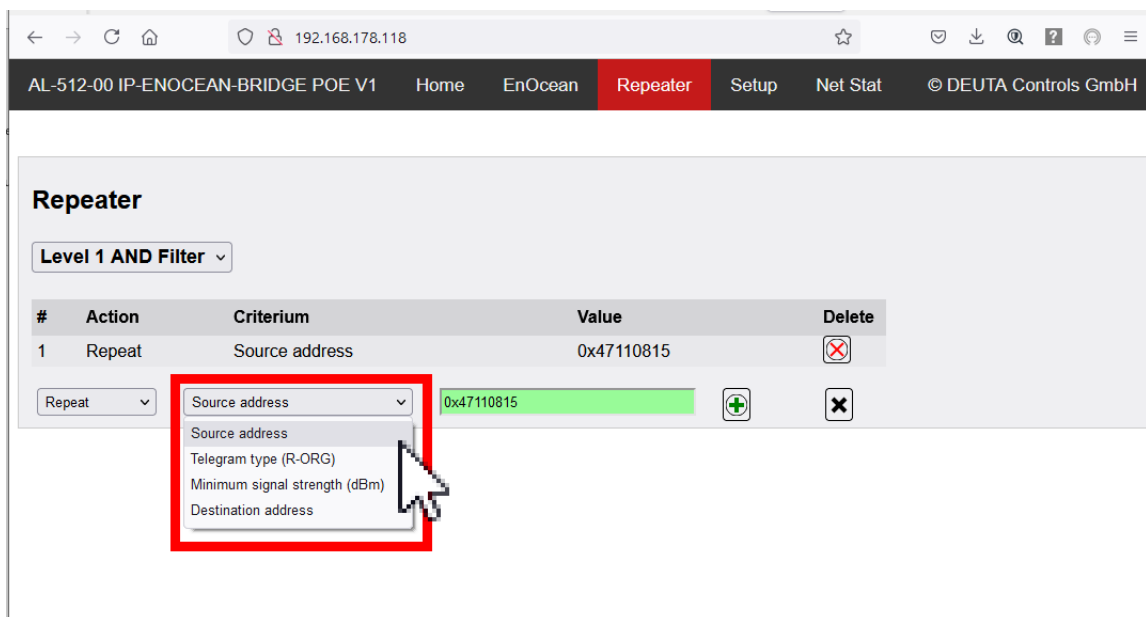


Figure 3: Repeater / Criterium

### 7.3.4 Repeater / Criterium value

Depending on the selected criterium, a value has to be selected / entered:

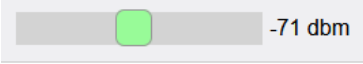
Criterion	Value
Destination address	EURID in HEX (0xnxxxxxxxx)
Telegram type	<ul style="list-style-type: none"> <li>RPS (F6)</li> <li>4BS (A5)</li> <li>1BS (D5)</li> <li>VLD (D2)</li> <li>MSC (D1)</li> <li>SIG (D0)</li> <li>UTE (D4)</li> </ul>
Minimum signal strength (dBm)	-90 .. -50 dBm, selected by the slider 
Source address	EURID in HEX (0xnxxxxxxxx)

Table 10: Repeater criterium

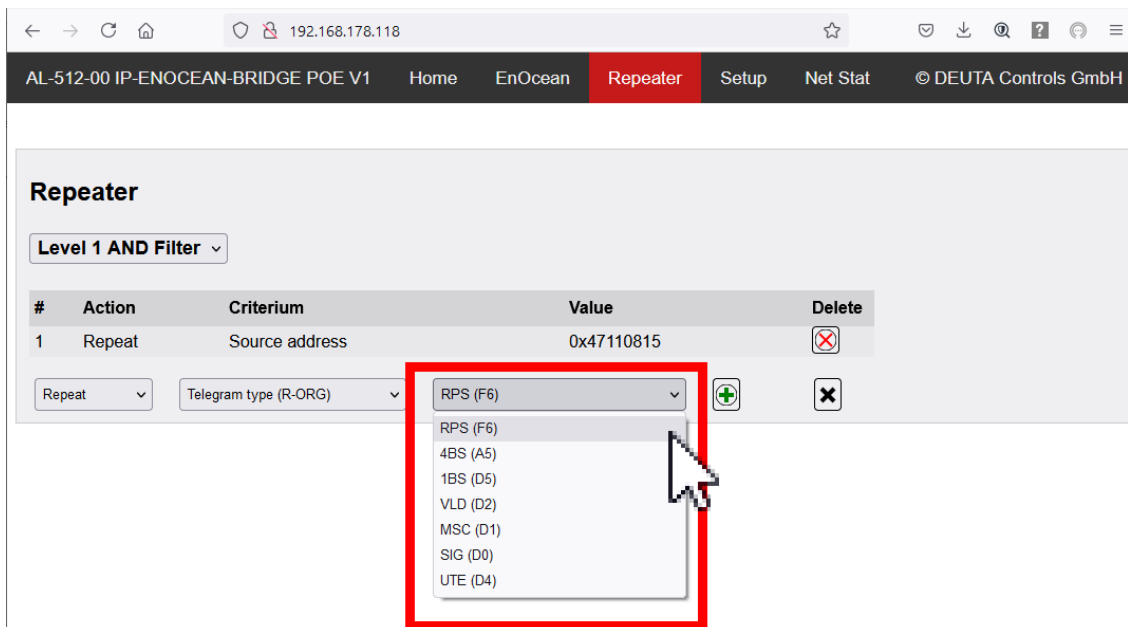


Figure 4: Repeater / Value dropdown for telegram type



Figure 5: Repeater criterium value signal strength

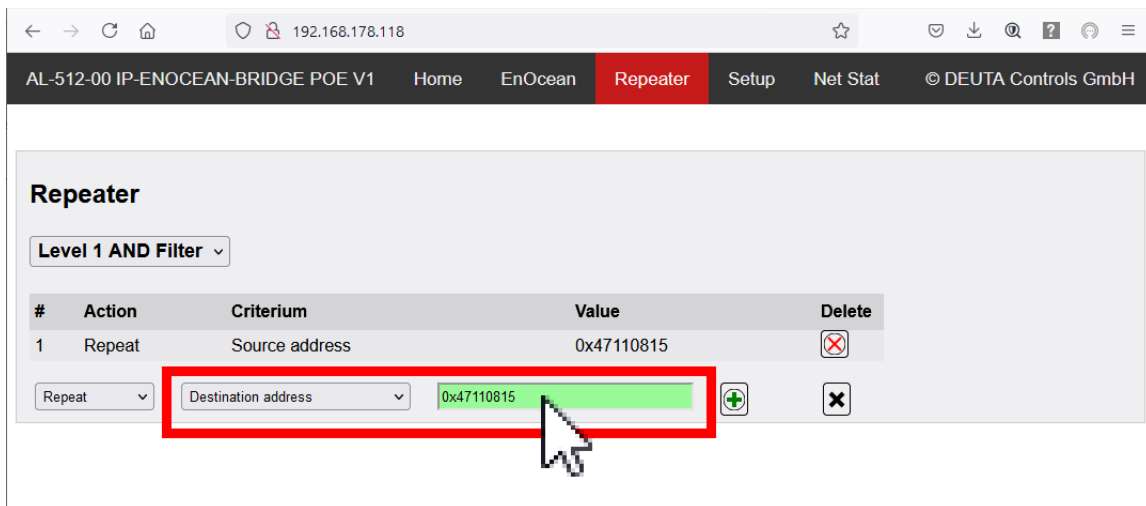
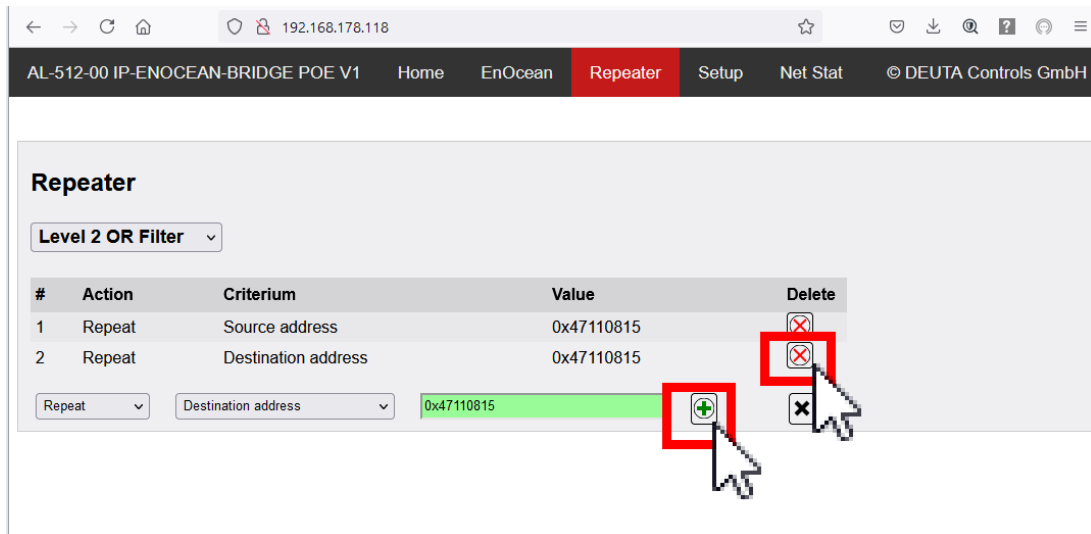


Figure 6: Repeater criterium value source / destination address

### 7.3.5 Add or remove rules for the repeater

Using the “+” and “-” buttons, you can add or remove rules from the list.



## 7.4 “Setup” / Ethernet and EnOcean interface properties

### 7.4.1 Password

The page is password protected, to avoid any unwanted change of the device parameters. The password is dynamic, and is based on the system time

The password is defined as follows:

System time of the PC = hh:mm

Password to enter = mm:hh

**Note:** The colon is part of the password and must be entered.

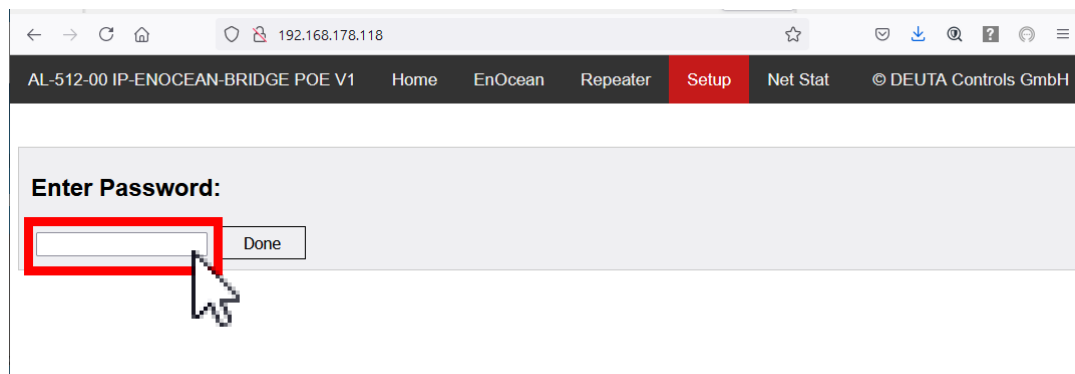


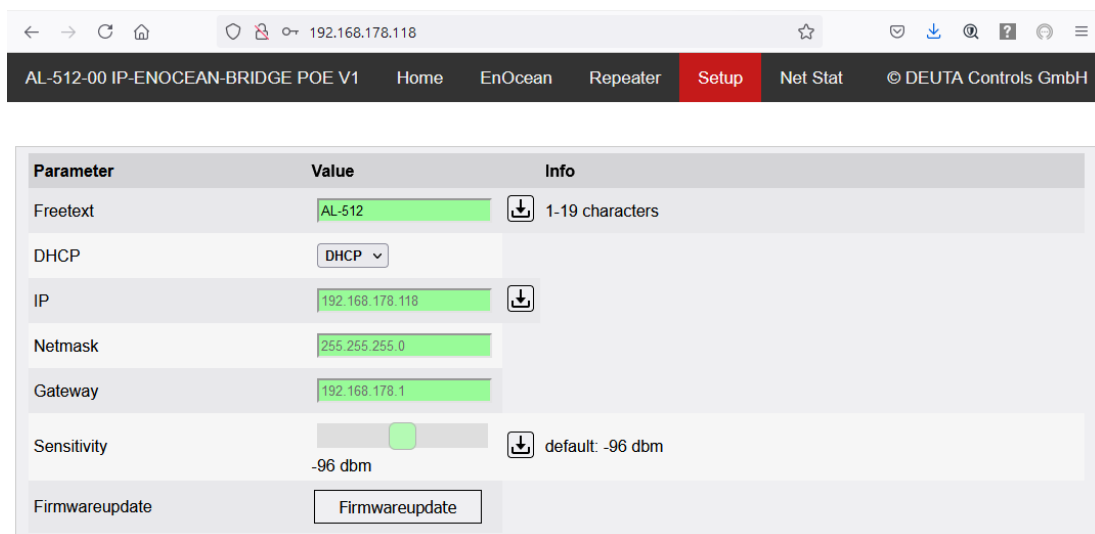
Figure 7: Password protection



## 7.4.2 Device properties

On this page, user can edit the following wireless and wired interface parameters:

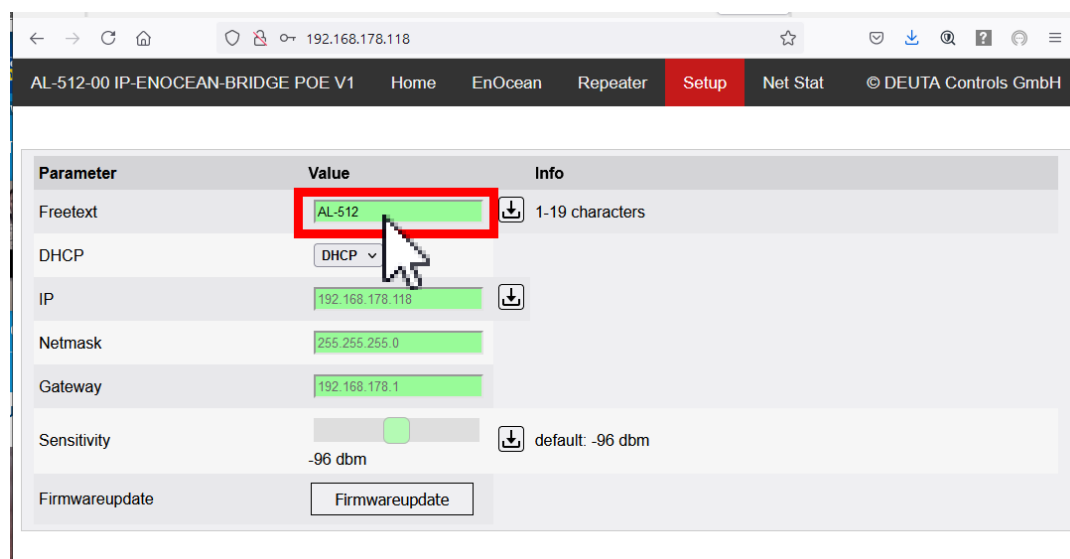
- Free text / device name
- DHCP or Static IP address
- IP address
- Subnet mask
- Gateway
- Sensitivity of EnOcean receiver: -90 .. -102 dbm (default: -96 dbm)



Parameter	Value	Info
Freertext	AL-512	1-19 characters
DHCP	DHCP	
IP	192.168.178.118	
Netmask	255.255.255.0	
Gateway	192.168.178.1	
Sensitivity	-96 dbm	default: -96 dbm
Firmwareupdate	Firmwareupdate	

### 7.4.2.1 Freertext

To identify the device, a free text can be entered (up to 19 characters).



Parameter	Value	Info
Freertext	AL-512	1-19 characters
DHCP	DHCP	
IP	192.168.178.118	
Netmask	255.255.255.0	
Gateway	192.168.178.1	
Sensitivity	-96 dbm	default: -96 dbm
Firmwareupdate	Firmwareupdate	

### 7.4.2.2 DHCP

The EnoDisc® supports DHCP or a static assigned address. Depending on the Drop down list selection, DHCP mode is activated or not.

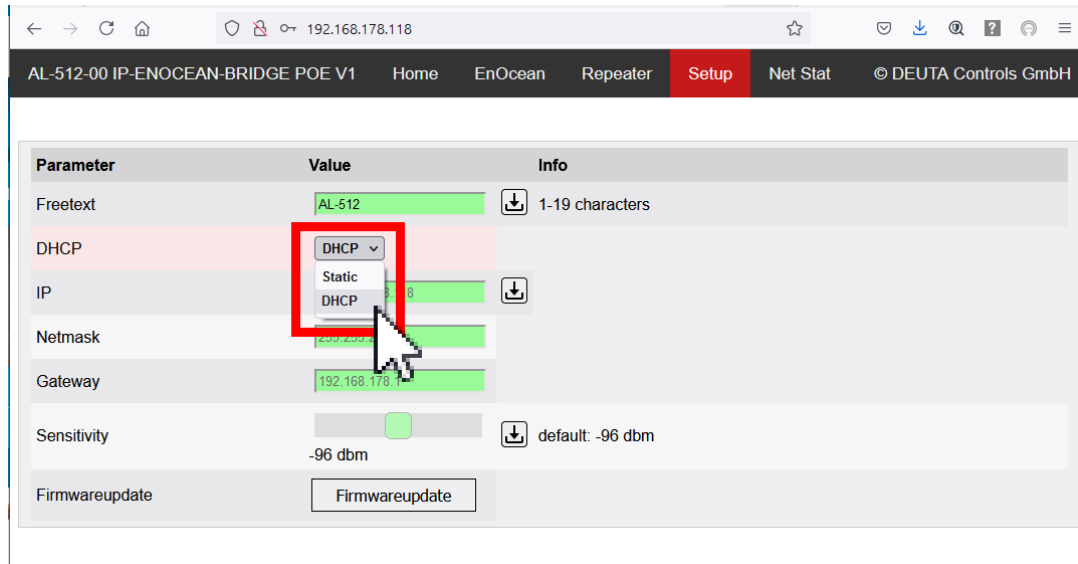


Figure 8: Select DHCP or static IP address

### 7.4.2.3 IP / Netmask / Gateway

When “Static” is selected in the drop down list, the static IP address, netmask and gateway address can be changed. To store, the according button has to be pressed once. All three parameters will be changed at the same time.

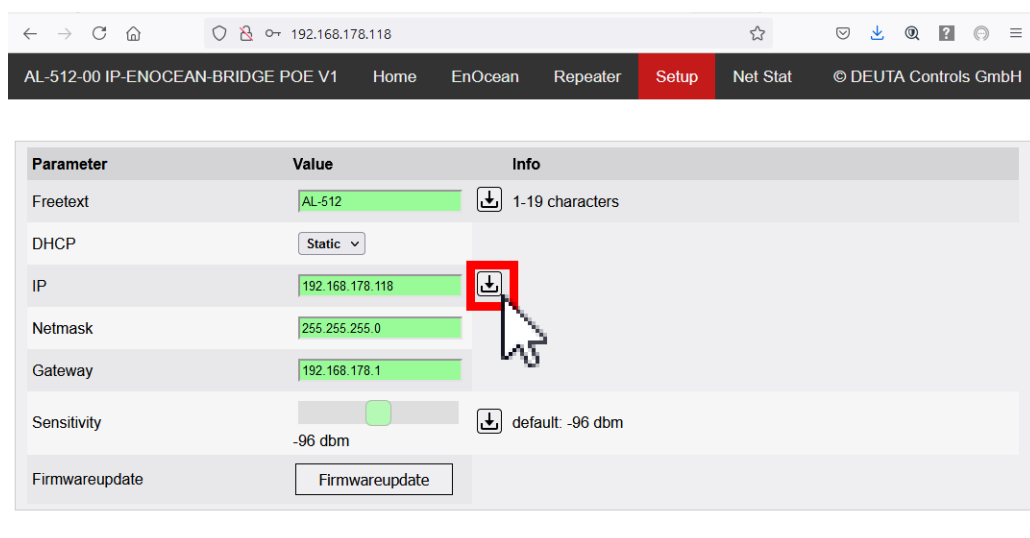


Figure 9: IP address selection / static or DHCP

#### 7.4.2.4 EnOcean receiver sensitivity

By default, a sensitivity of -96 dBm has been configured for the EnOcean receiver as the factory default. This provides the best performance in most of the applications. Sometimes, it might help to increase / decrease the sensitivity to optimize a single EnoDisc of a system depending on the surrounding environment

User can finetune the sensitivity in a range from -90 dBm (less sensitive) up to - 102 dBm (more sensitive).

Use the slider to select the value, and then push the Store button.

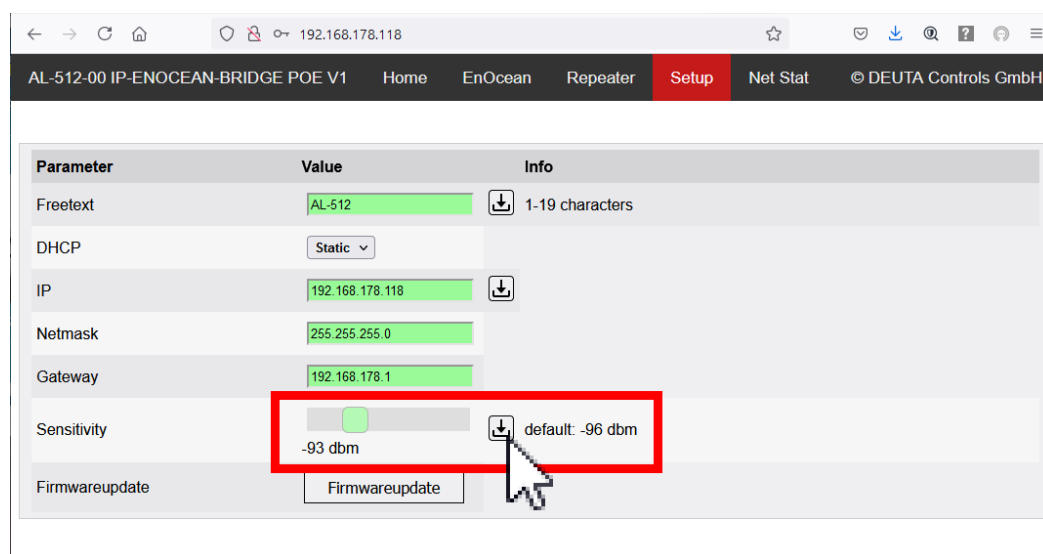


Figure 10: Set EnOcean receiver sensitivity

#### 7.4.2.5 EnoDisc Firmware update

Firmware of the device can be updated at any time via Ethernet. Push the button "Firmwareupdate" to start.

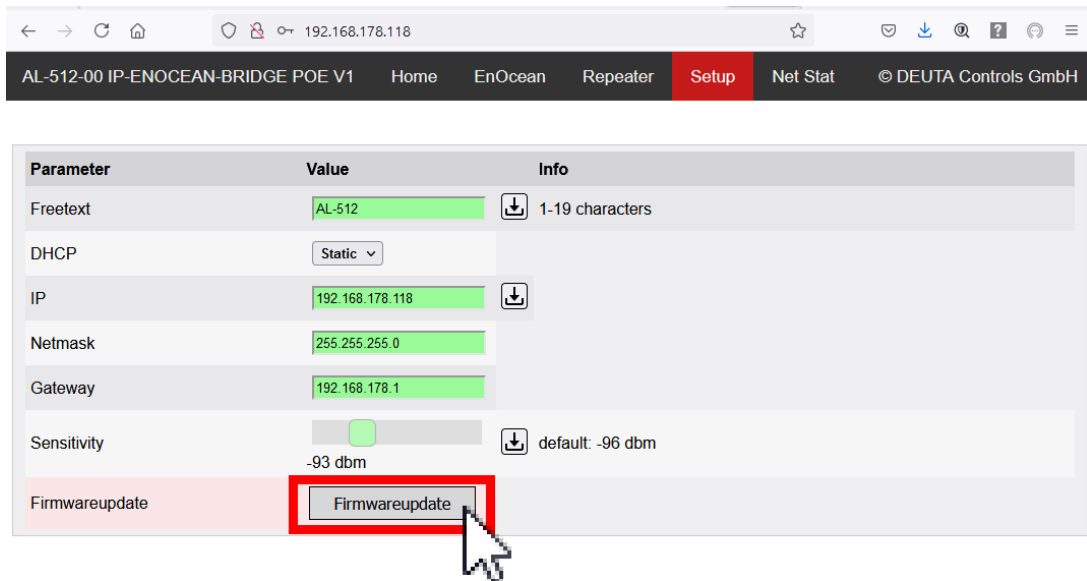


Figure 11: Start firmware update dialog / enter bootloader

After the button has been pushed, EnoDisc will enter into bootloader mode. Progress will be shown (0..100%).

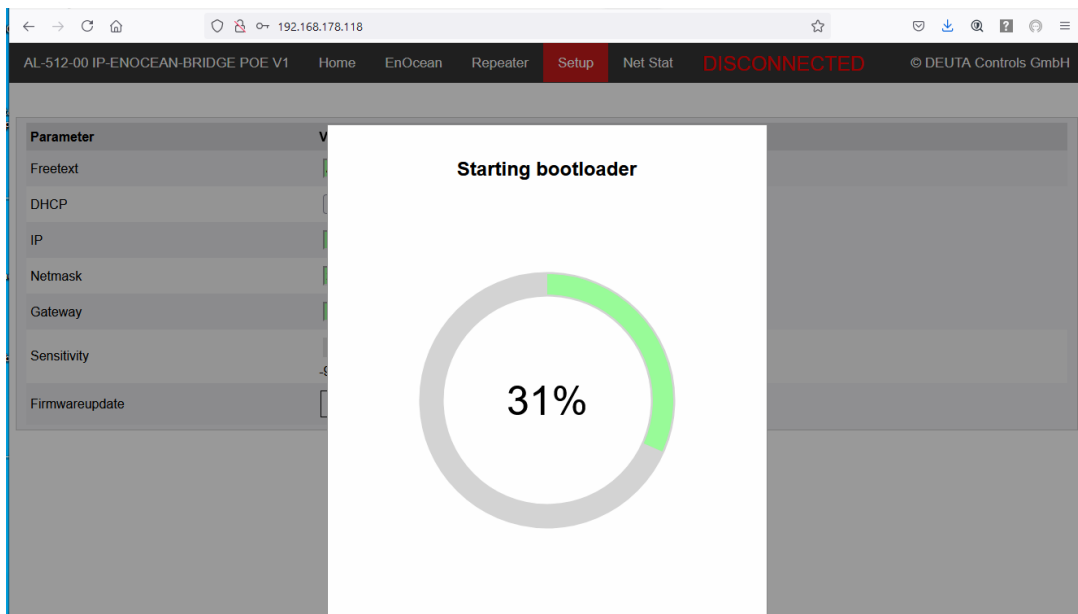


Figure 12: EnoDisc entering bootloader mode

When bootloader mode has been started, the page will show the actual properties, and also the actual firmware version.

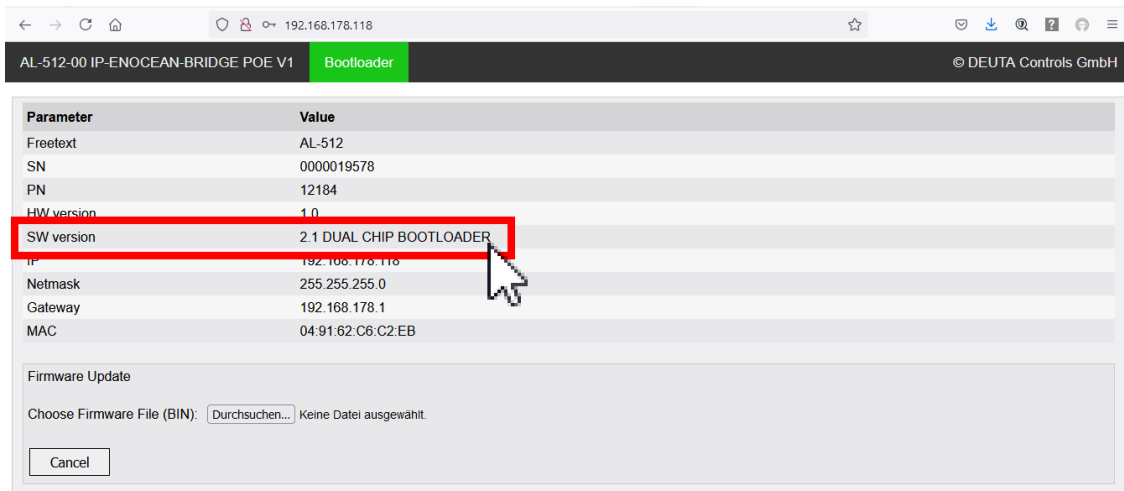


Figure 13: EnoDisc in bootloader mode

If a new firmware should be loaded, select the new bin-file from your PC, and push the button “Update”. To exit from the bootloader, you can push “Cancel” at any time.

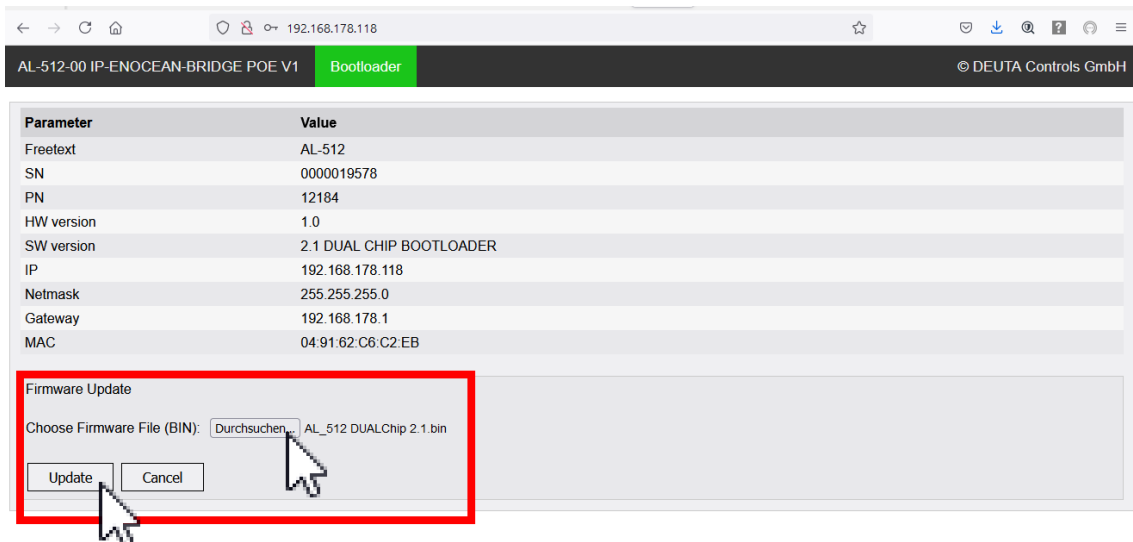


Figure 14: Start firmware update

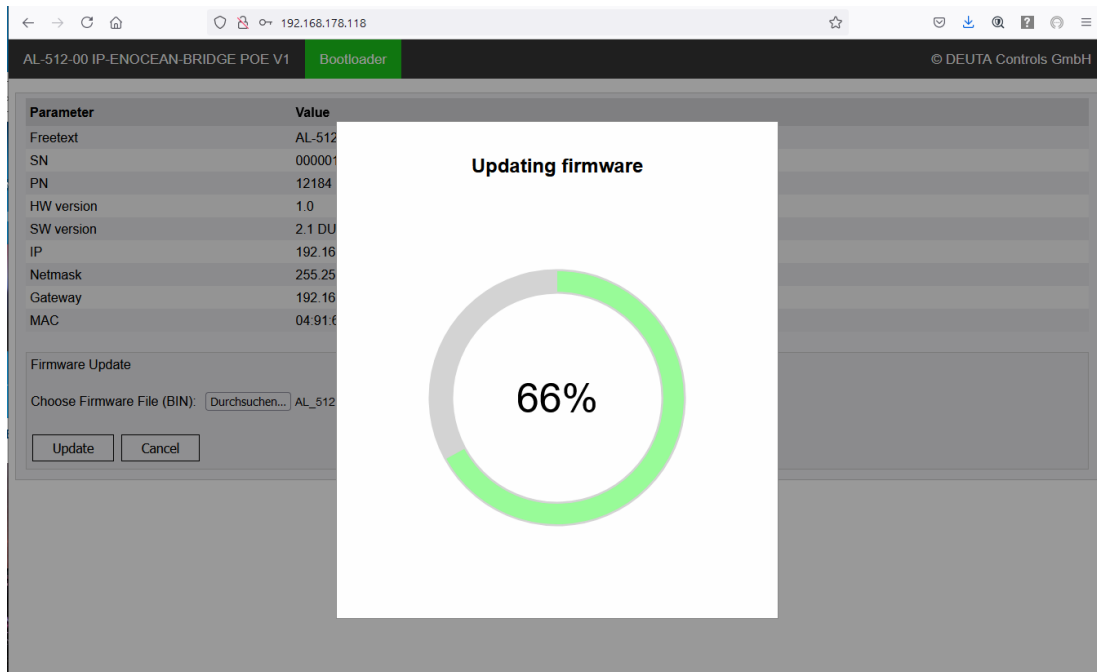


Figure 15: Firmware update in progress

When the firmware update has been processed correctly, the EnOcean will start in normal mode automatically. You can check for the new SW version in the table shown on the page “Home”.

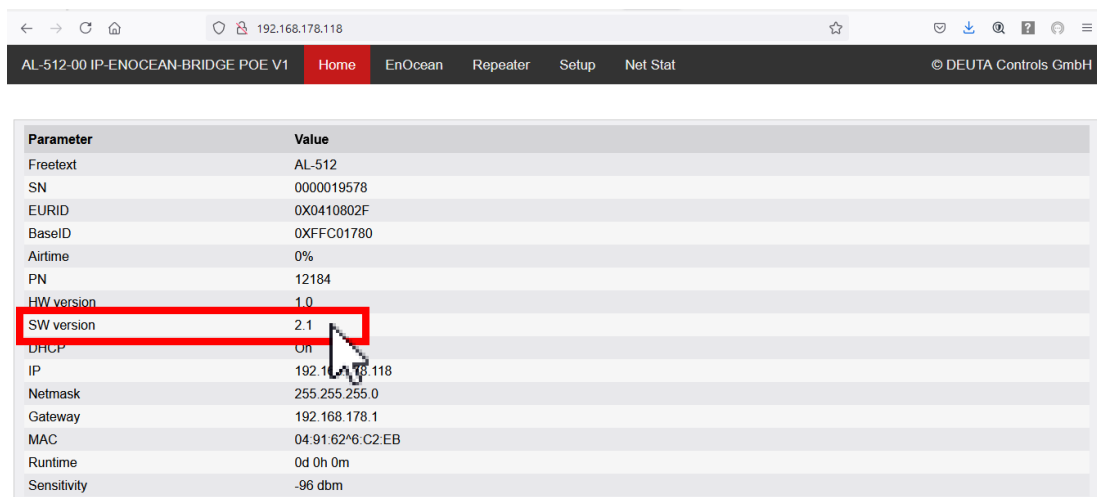


Figure 16: Firmware updated with success

## 7.4.2.6 Mailbox for EnOcean SmartAck devices

The EnoDisc supports the SmartAck mechanism as defined by the EnOcean specification.

## 7.5 Supported EEP's (EnOcean Equipment Profiles)

### 7.5.1 Transmit / TX and Receive / RX

The EnOcean wireless standard defines so called EnOcean Equipment Profiles (EEP). Each EnOcean based product sends and receives data according to at least one standardized data format. The EnoDisc transmits and receives data independent of the EEP, since contents of the messages are not interpreted.

As a result, the EnoDisc is in principle a transparent bi-directional gateway between EnOcean and Ethernet.

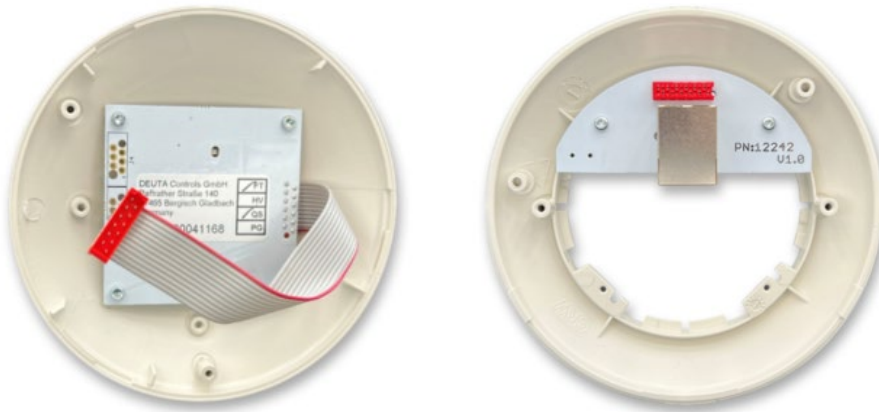
## 8 Installation and maintenance / service



**Caution:** When opening the device, you have to take care of electrostatic discharge. Otherwise, electronics will be damaged.

The following picture shows the main parts of an EnoDisc:

- Right: Connector board / lower part of housing
- Left: Controller board / upper part of housing



To mount the EnoDisc to the ceiling, you have to mount the socket first. Use two screws as needed for the material of the ceiling. Check if you should drill a hole for the Ethernet cable in advance, as shown in the following picture.





Connect the Patch Cable to the connector board.

Finally connect controller board of the EnoDisc® with the flat ribbon cable to the connector board. and close the housing.



## 9 Device labels

The following labels are placed on the housing of the AL-512-01-921 white:



**MAC-Address:**

**00:00:00:00:00:00**

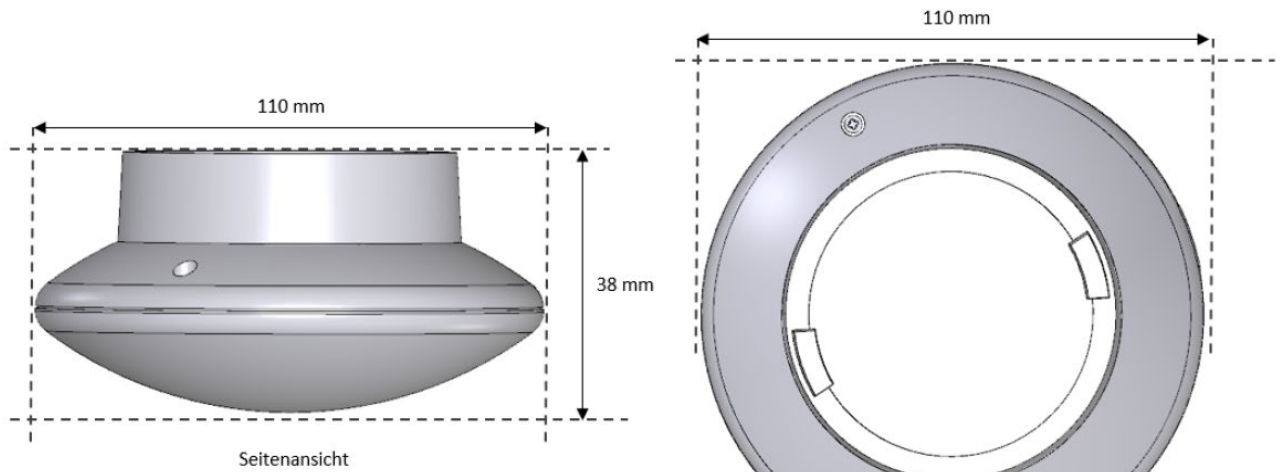
**SN: 0000026177**

## 10 NCC statement

取得審驗證明之低功率射頻器材，非經核准，公司、商號或使用者均不得擅自變更頻率、加大功率或變更原設計之特性及功能。低功率射頻器材之使用不得影響飛航安全及干擾合法通信；經發現有干擾現象時，應立即停用，並改善至無干擾時方得繼續使用。前述合法通信，指依電信管理法規定作業之無線電通信。低功率射頻器材須忍受合法通信或工業、科學及醫療用電波輻射性電機設備之干擾。

## 11 Dimensions / drawings

Diameter: 110 mm; Height: approx. 38 mm when mounted



## 12 RoHS Table

设备名称: AL-512-01-921 ; 型号: AL-512-01-921 白色 Equipment name      Type designation (Type)						
單元 Unit	限用物質及其化學符號 Restricted substances and its chemical symbols					
	鉛 Lead (Pb)	汞 Mercury (Hg)	鎘 Cadmium (Cd)	六價鉻 Hexavalent chromium (Cr <sup>+6</sup> )	多溴聯苯 Polybrominated biphenyls (PBB)	多溴二苯醚 Polybrominated diphenyl ethers (PBDE)
两块电路板	—	○	○	○	○	○
外壳螺丝	○	○	○	○	○	○
住房	○	○	○	○	○	○
连接线	○	○	○	○	○	○
<p>備考1. “超出0.1 wt %” 及 “超出0.01 wt %” 係指限用物質之百分比含量超出百分比含量基準值。 Note 1 : “Exceeding 0.1 wt %” and “exceeding 0.01 wt %” indicate that the percentage content of the restricted substance exceeds the reference percentage value of presence condition.</p> <p>備考2. “○” 係指該項限用物質之百分比含量未超出百分比含量基準值。 Note 2 : “○” indicates that the percentage content of the restricted substance does not exceed the percentage of reference value of presence.</p> <p>備考3. “—” 係指該項限用物質為排除項目。 Note 3 : The “—” indicates that the restricted substance corresponds to the exemption.</p>						

---

## 13 Ordering information

### Ordering information

Article text	Part nr.	Description
AL-512-01-921 white	12516	EnoDisc®, Bidirectional bridge between EnOcean and Ethernet TCP; power supply by PoE; communication via ESP3 (EnOcean Serial Protocol 3); EnOcean 921 MHz; NCC, TAIWAN; on-wall housing, threepart; weight: 95 g, operating temp.: 0°C - 45°C storage temp.: -20°C - 70°C, humidity: 5 - 90% RH, non-condensing; connector: RJ45;

---

## List of tables

Table 1: Technical data / Wireless communication EnOcean ..... 7

Table 2: Technical data / communication ..... 7

Table 3: Technical data / user interfaces ..... 7

Table 4: Technical data / housing ..... 7

Table 5: Technical data / power supply ..... 8

Table 6: Technical data / environmental conditions ..... 8

Table 7: Technical data / dimensions and weight ..... 8

Table 8: Technical data / tests and approvals ..... 8

Table 9: Technical data / Standards / approvals ..... 8

Table 10: Repeater criterium ..... 14

## 14 Revision history

Version	Author	Reviewer	Date	Major changes
1.00	Lehzen	Pohl	27.07.2023	Initial release
1.13	Lehzen	Pohl	07.08.2023	Added NCC statement
1.14	Lehzen	Pohl	06.09.2023	Corrected table 5.1; Added RoHS Table / chapter 12

----- End of document -----